

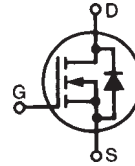
# PolarHV™ HiPerFET IXFR 64N50P

## Power MOSFET

### ISOPLUS247™

(Electrically Isolated Back Surface)

N-Channel Enhancement Mode  
Avalanche Rated  
Fast Intrinsic Diode



$$V_{DSS} = 500 \text{ V}$$

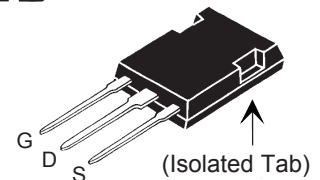
$$I_{D25} = 35 \text{ A}$$

$$R_{DS(on)} \leq 95 \text{ m}\Omega$$

$$t_{rr} \leq 200 \text{ ns}$$

Symbol	Test Conditions	Maximum Ratings	
$V_{DSS}$	$T_J = 25^\circ\text{C}$ to $150^\circ\text{C}$	500	V
$V_{DGR}$	$T_J = 25^\circ\text{C}$ to $150^\circ\text{C}$ ; $R_{GS} = 1 \text{ M}\Omega$	500	V
$V_{GSS}$	Continuous	$\pm 30$	V
$V_{GSM}$	Transient	$\pm 40$	V
$I_{D25}$	$T_C = 25^\circ\text{C}$	35	A
$I_{DM}$	$T_C = 25^\circ\text{C}$ , pulse width limited by $T_{JM}$	150	A
$I_{AR}$	$T_C = 25^\circ\text{C}$	43	A
$E_{AR}$	$T_C = 25^\circ\text{C}$	80	mJ
$E_{AS}$	$T_C = 25^\circ\text{C}$	2.5	J
$dv/dt$	$I_S \leq I_{DM}$ , $di/dt \leq 100 \text{ A}/\mu\text{s}$ , $V_{DD} \leq V_{DSS}$ , $T_J \leq 150^\circ\text{C}$ , $R_G = 4 \Omega$	20	V/ns
$P_D$	$T_C = 25^\circ\text{C}$	300	W
$T_J$		-55 ... +150	$^\circ\text{C}$
$T_{JM}$		150	$^\circ\text{C}$
$T_{stg}$		-55 ... +150	$^\circ\text{C}$
$T_L$	1.6 mm (0.062 in.) from case for 10 s	300	$^\circ\text{C}$
$V_{ISOL}$	50/60 Hz, RMS, 1 minute	2500	V~
$F_d$	Mounting force	20..120 / 4.5..26	N/lb
<b>Weight</b>		5	g

ISOPLUS247 (IXFR)  
E153432



G = Gate  
S = Source  
D = Drain

#### Features

- | Silicon chip on Direct-Copper-Bond substrate
- High power dissipation
- Isolated mounting surface
- 2500V electrical isolation
- | Low drain to tab capacitance (<30pF)
- | Low  $R_{DS(on)}$  HDMOS™ process
- | Rugged polysilicon gate cell structure
- | Rated for Unclamped Inductive Load Switching (UIS)
- | Fast intrinsic Rectifier

#### Applications

- | DC-DC converters
- | Battery chargers
- | Switched-mode and resonant-mode power supplies
- | DC choppers
- | AC motor control

#### Advantages

- | Easy assembly
- | Space savings
- | High power density

Symbol	Test Conditions ( $T_J = 25^\circ\text{C}$ , unless otherwise specified)	Characteristic Values		
		Min.	Typ.	Max.
$BV_{DSS}$	$V_{GS} = 0 \text{ V}$ , $I_D = 250 \mu\text{A}$	500		V
$V_{GS(th)}$	$V_{DS} = V_{GS}$ , $I_D = 8 \text{ mA}$	3.0		5.5 V
$I_{GSS}$	$V_{GS} = \pm 30 \text{ V}_{DC}$ , $V_{DS} = 0$			$\pm 200 \text{ nA}$
$I_{DSS}$	$V_{DS} = V_{DSS}$ , $V_{GS} = 0 \text{ V}$			25 $\mu\text{A}$ 1000 $\mu\text{A}$
$R_{DS(on)}$	$V_{GS} = 10 \text{ V}$ , $I_D = 32 \text{ A}$ , Note 1 $T_J = 125^\circ\text{C}$			95 m $\Omega$

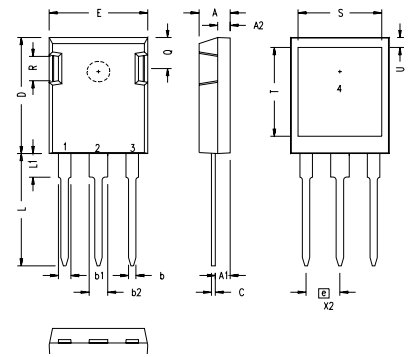
Symbol	Test Conditions	Characteristic Values ( $T_J = 25^\circ\text{C}$ , unless otherwise specified)		
		Min.	Typ.	Max.
$g_{fs}$	$V_{DS} = 20\text{ V}; I_D = 32\text{ A}$ , Note 1	30	50	S
$C_{iss}$	$V_{GS} = 0\text{ V}, V_{DS} = 25\text{ V}, f = 1\text{ MHz}$		8700	pF
$C_{oss}$			970	pF
$C_{rss}$			90	pF
$t_{d(on)}$	$V_{GS} = 10\text{ V}, V_{DS} = 0.5 V_{DSS}, I_D = 32\text{ A}$ $R_G = 2\ \Omega$ (External)		30	ns
$t_r$			25	ns
$t_{d(off)}$			85	ns
$t_f$			22	ns
$Q_{g(on)}$	$V_{GS} = 10\text{ V}, V_{DS} = 0.5 V_{DSS}, I_D = 32\text{ A}$		150	nC
$Q_{gs}$			50	nC
$Q_{gd}$			50	nC
$R_{thJC}$			0.42	$^\circ\text{C/W}$
$R_{thCS}$		0.15		$^\circ\text{C/W}$

Symbol	Test Conditions	Characteristic Values ( $T_J = 25^\circ\text{C}$ , unless otherwise specified)		
		Min.	Typ.	Max.
$I_S$	$V_{GS} = 0\text{ V}$			64 A
$I_{SM}$	Repetitive			150 A
$V_{SD}$	$I_F = I_S, V_{GS} = 0\text{ V}$ , Note 1			1.5 V
$t_{rr}$	$I_F = 25\text{ A}, -di/dt = 100\text{ A}/\mu\text{s}$ $V_R = 100\text{ V}$			200 ns
$Q_{RM}$			0.6	$\mu\text{C}$
$I_{RM}$			6.0	A

**Notes:**

1. Pulse test,  $t \leq 300\ \mu\text{s}$ , duty cycle  $d \leq 2\%$

**ISOPLUS247 Outline**

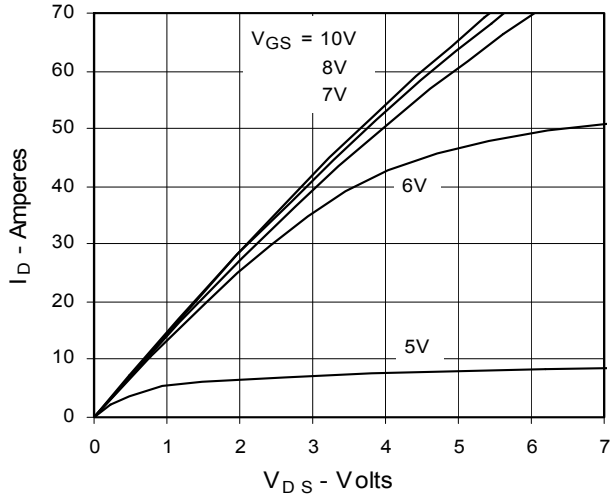


SYM	INCHES		MILLIMETERS	
	MIN	MAX	MIN	MAX
A	.190	.205	4.83	5.21
A1	.090	.100	2.29	2.54
A2	.075	.085	1.91	2.16
b	.045	.055	1.14	1.40
b1	.075	.084	1.91	2.13
b2	.115	.123	2.92	3.12
C	.024	.031	0.61	0.80
D	.819	.840	20.80	21.34
E	.620	.635	15.75	16.13
e	.215 BSC		5.45 BSC	
L	.780	.800	19.81	20.32
L1	.150	.170	3.81	4.32
Q	.220	.244	5.59	6.20
R	.170	.190	4.32	4.83
S	.520	.540	13.21	13.72
T	.620	.640	15.75	16.26
U	.065	.080	1.65	2.03

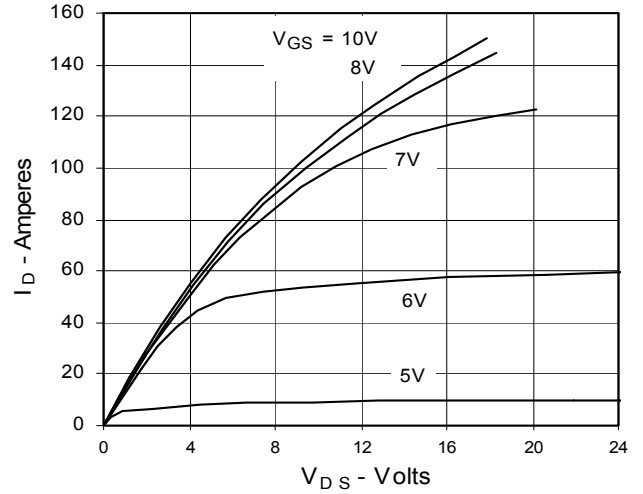
- 1 - GATE
- 2 - DRAIN (COLLECTOR)
- 3 - SOURCE (EMITTER)
- 4 - NO CONNECTION

NOTE: This drawing will meet all dimensions requirement of JEDEC outline TO-247AD except screw hole.

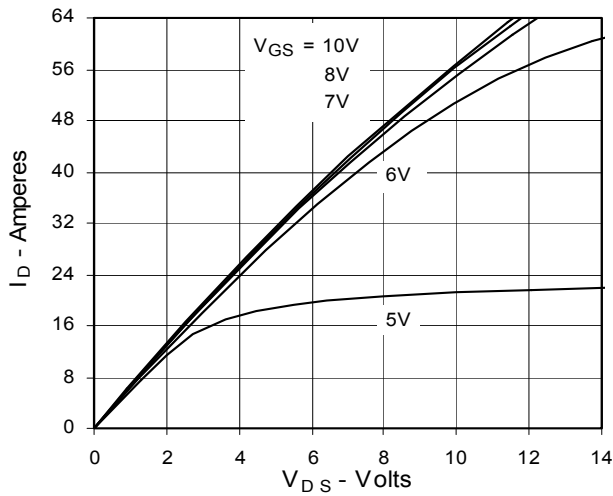
**Fig. 1. Output Characteristics**  
@ 25°C



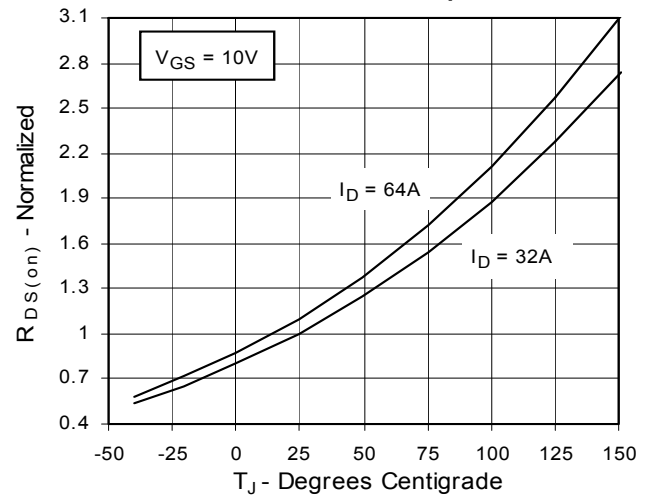
**Fig. 2. Extended Output Characteristics**  
@ 25°C



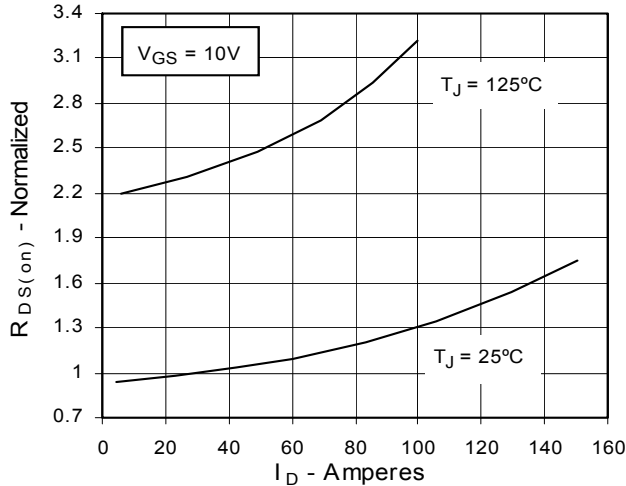
**Fig. 3. Output Characteristics**  
@ 125°C



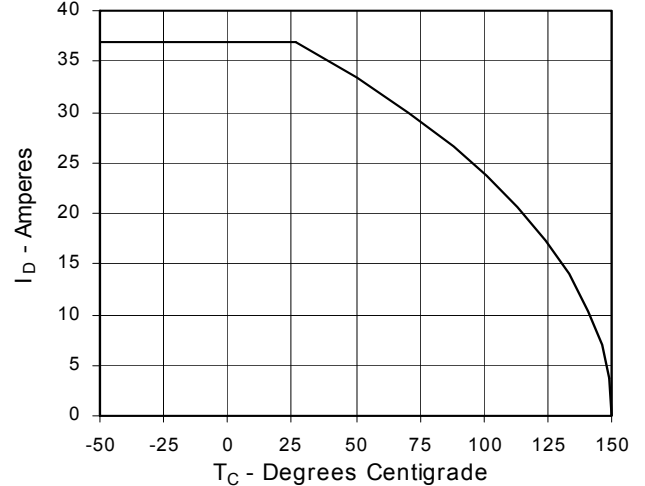
**Fig. 4.  $R_{DS(on)}$  Normalized to  $I_D = 32A$  Value vs. Junction Temperature**

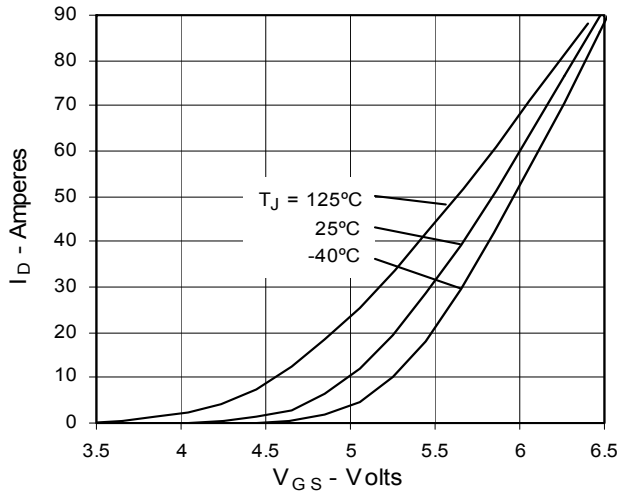
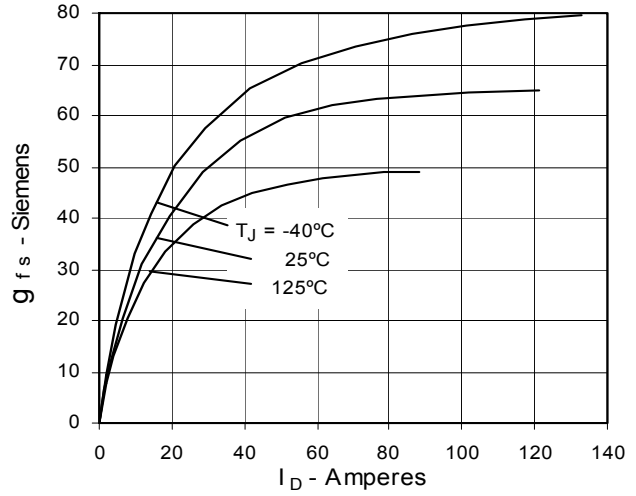
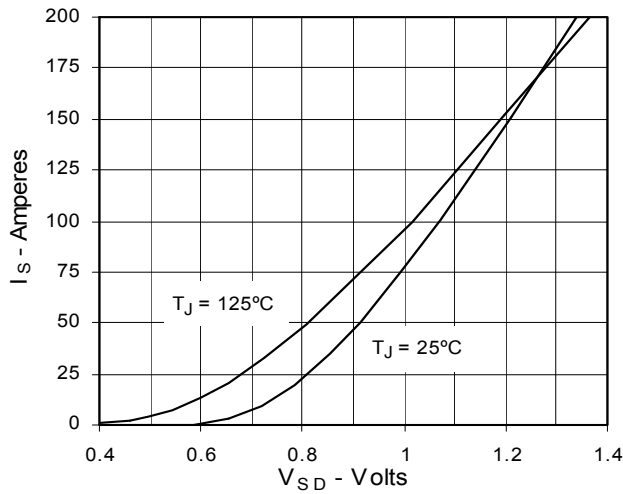
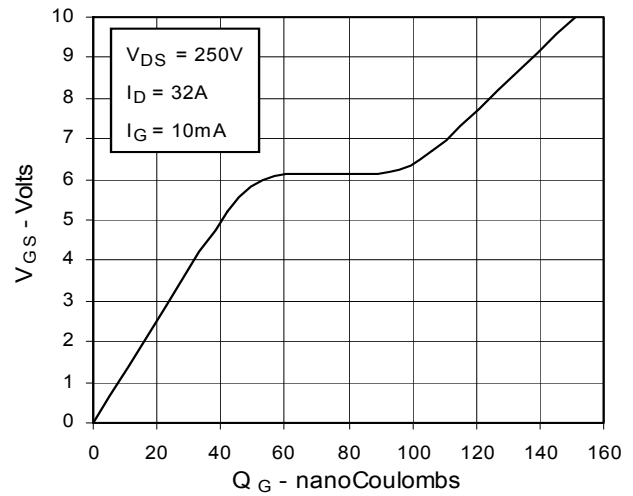
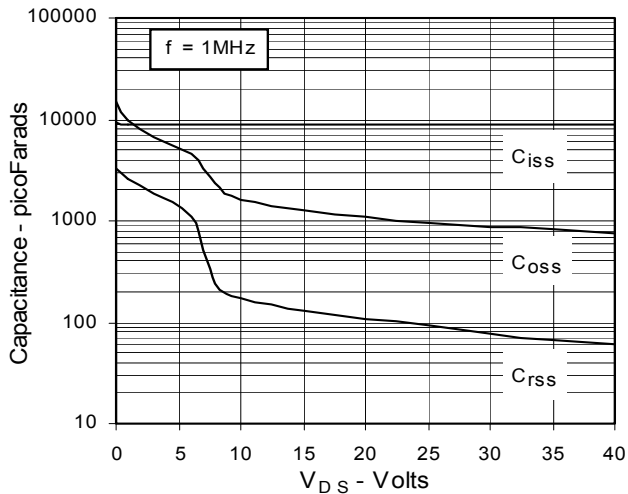


**Fig. 5.  $R_{DS(on)}$  Normalized to  $I_D = 32A$  Value vs. Drain Current**



**Fig. 6. Drain Current vs. Case Temperature**



**Fig. 7. Input Admittance**

**Fig. 8. Transconductance**

**Fig. 9. Source Current vs. Source-To-Drain Voltage**

**Fig. 10. Gate Charge**

**Fig. 11. Capacitance**

**Fig. 12. Maximum Transient Thermal Resistance**
